

All dimensions in millimetres unless otherwise stated. The contractor must verify all dimensions on site before commencing on site. Architect must be notified of any suspected discrepancies at the time of construction. Any scaled dimensions to be confirmed by the Architect.

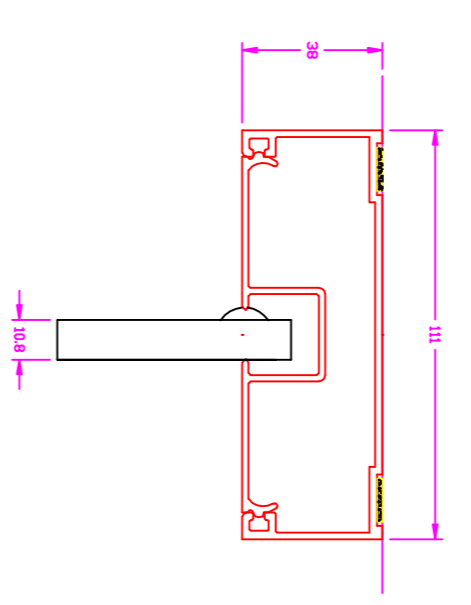

Section C-C

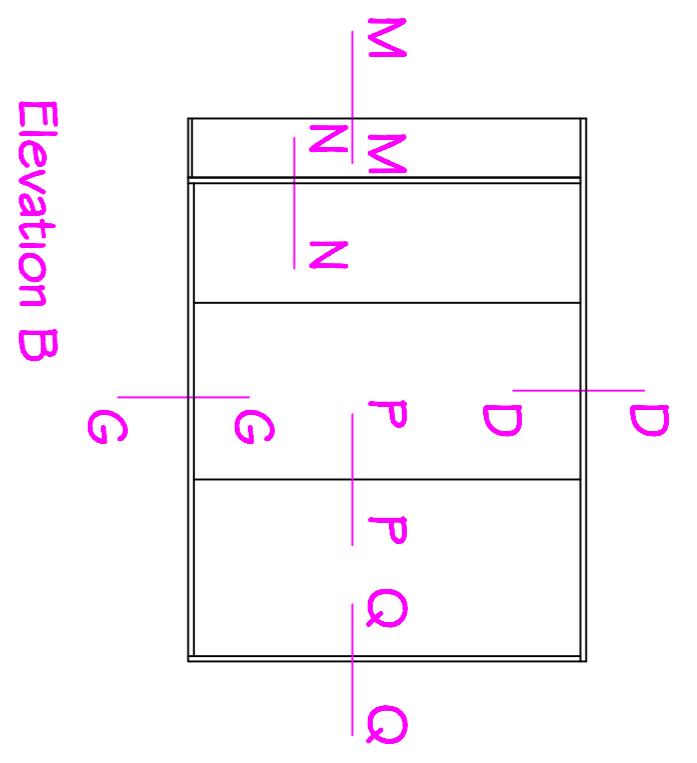
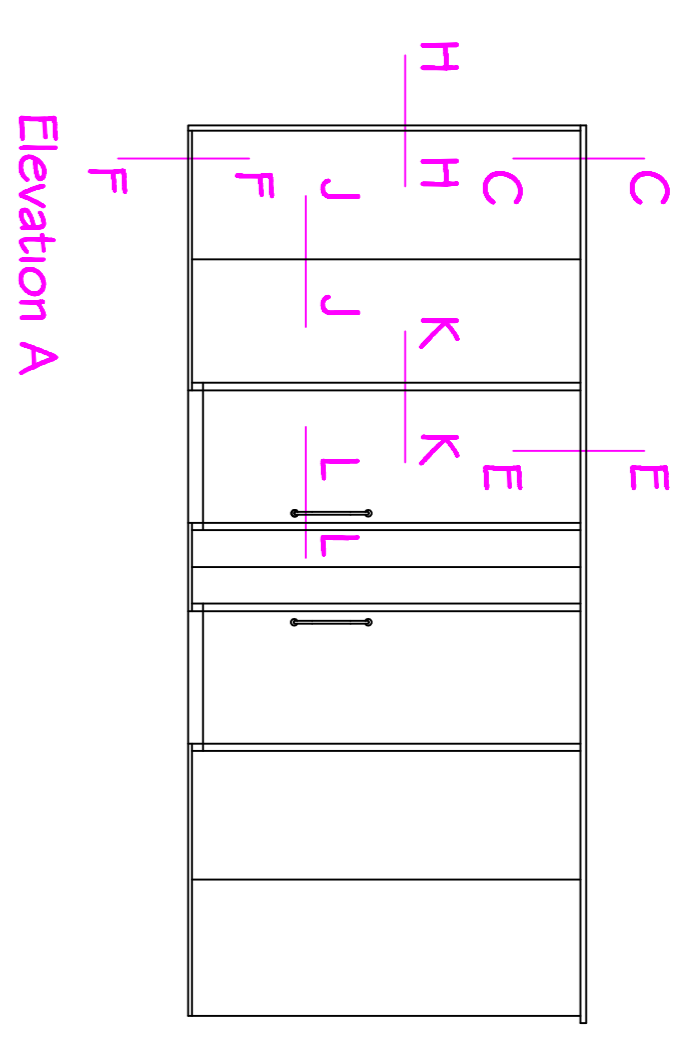
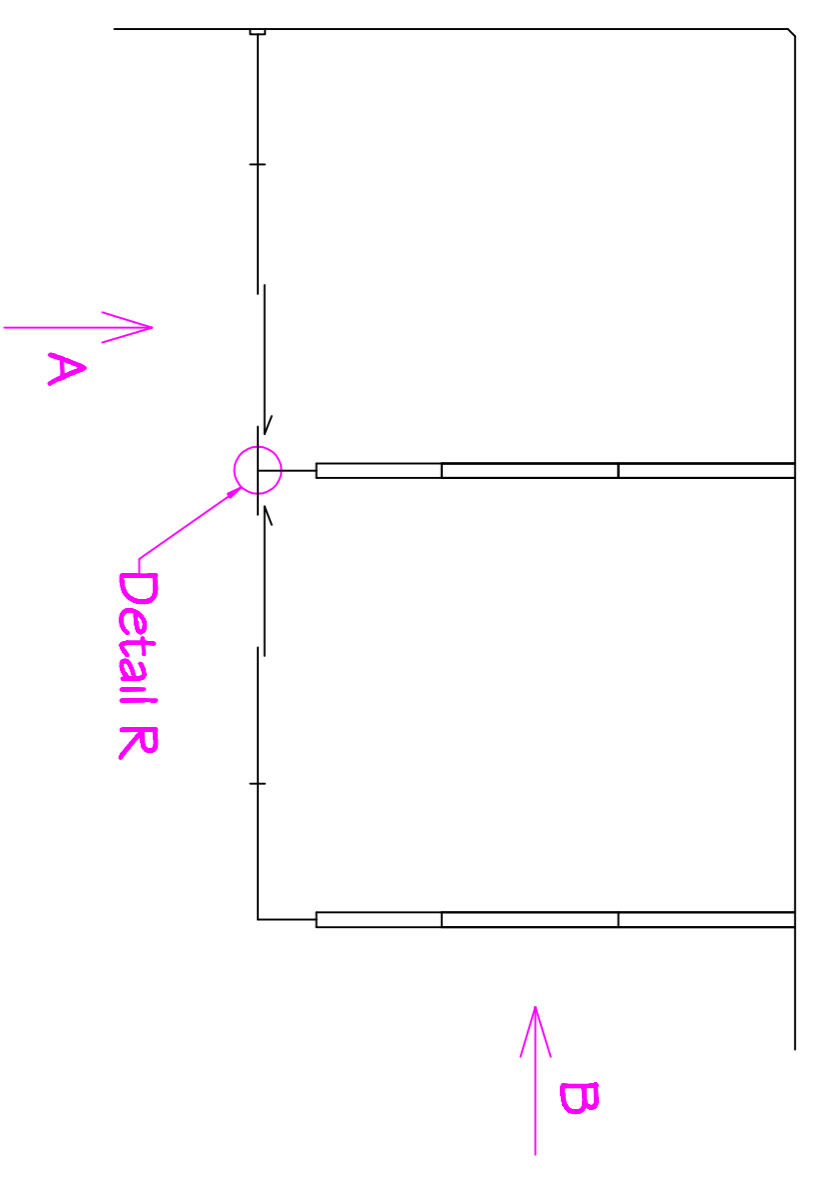
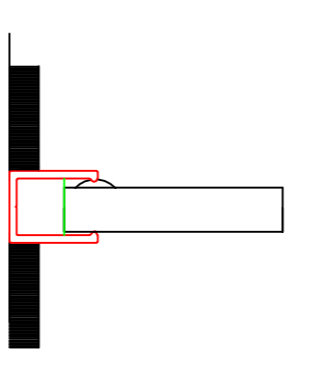

Section F-F

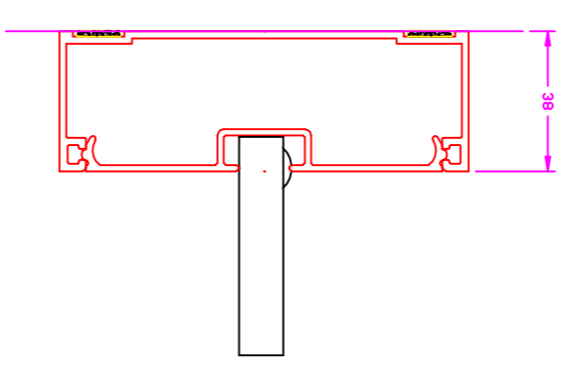

Section H-H

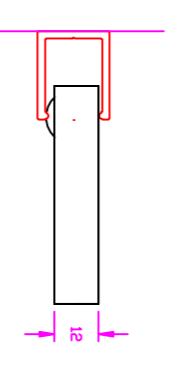

Section H-H Option 24mm/38mm

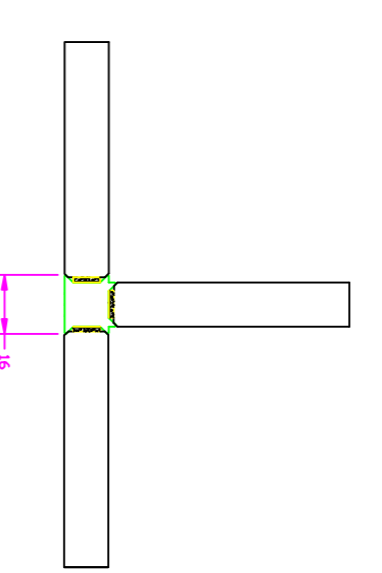

Detail R

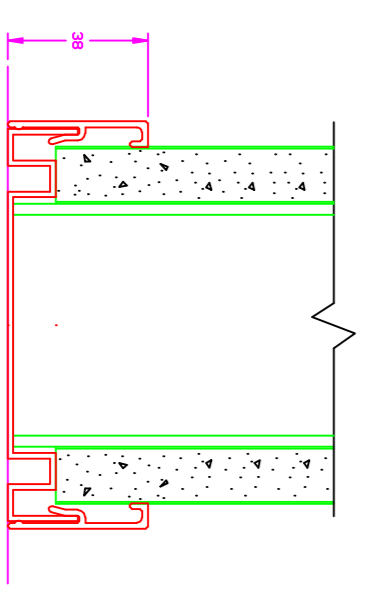

Section D-D

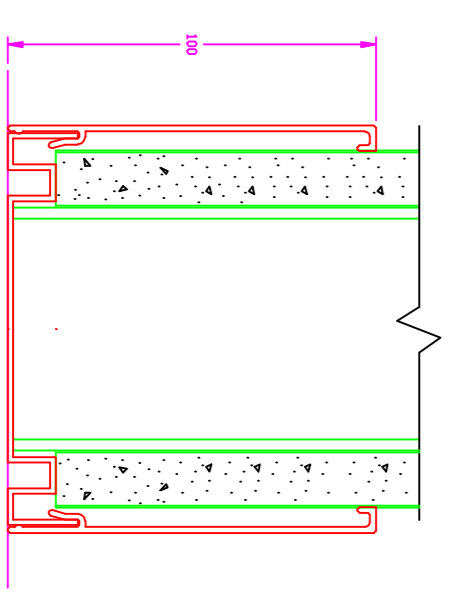

Section G-G

Section G-G 100mm Skirting Option

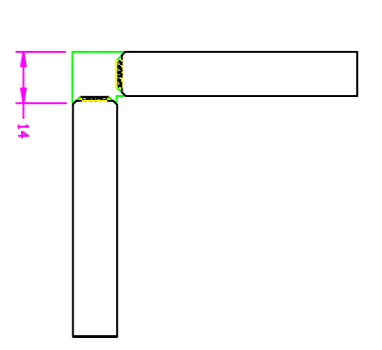

Section M-M

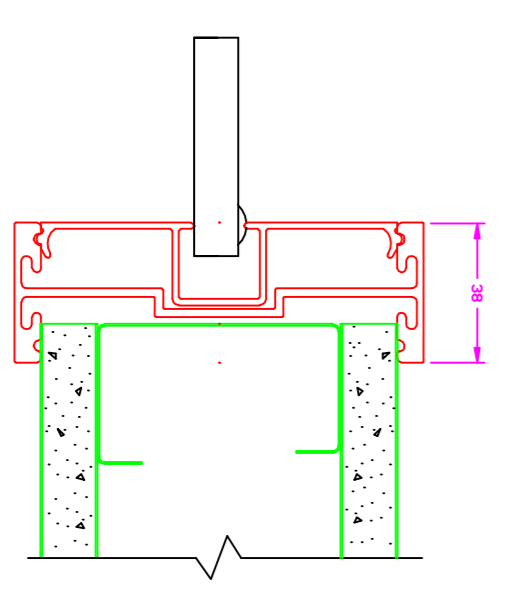

Section N-N

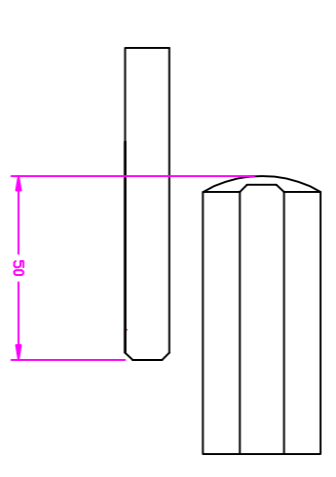

Section K-K

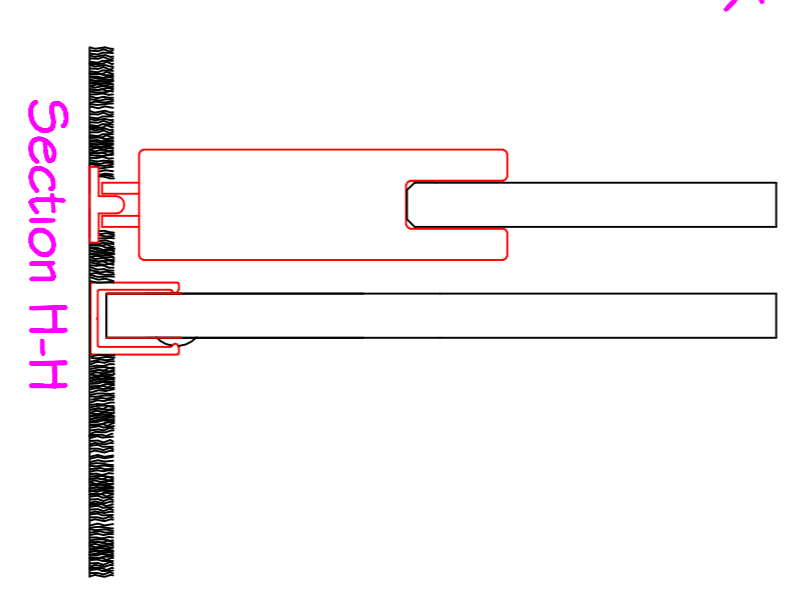

Section H-H

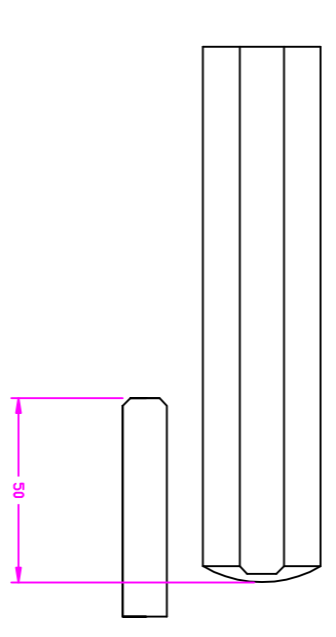

Section L-L

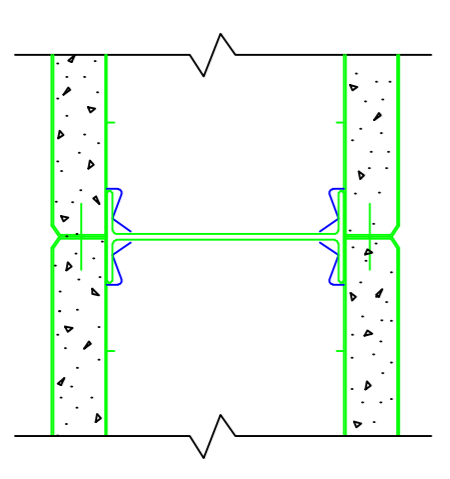

Section P-P

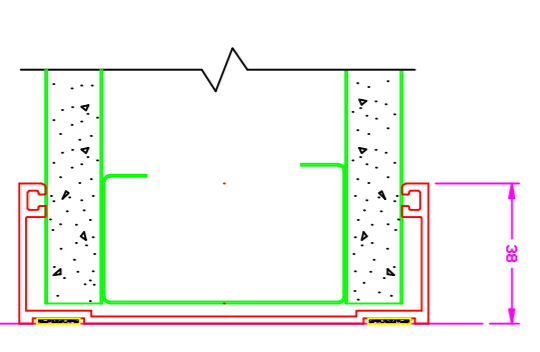

Section Q-Q

Project		Single Glazed Frameless	
Drawing Title		Demountable Solid and Sliding Doors	
Scale	1:50; 1:20@1	Date	08/12/08
Drawn by	D.SUTTON	Checked by	Approved by
Drawing Status			
<small> iWalk® is a registered trademark of iWalk®. All rights reserved. © 2008 iWalk®. All rights reserved. iWalk® is a registered trademark of iWalk®. All rights reserved. </small>			
Dwg No.		Rev.	
1003-4		A	